

PLAN VIEW W/OUT COVER

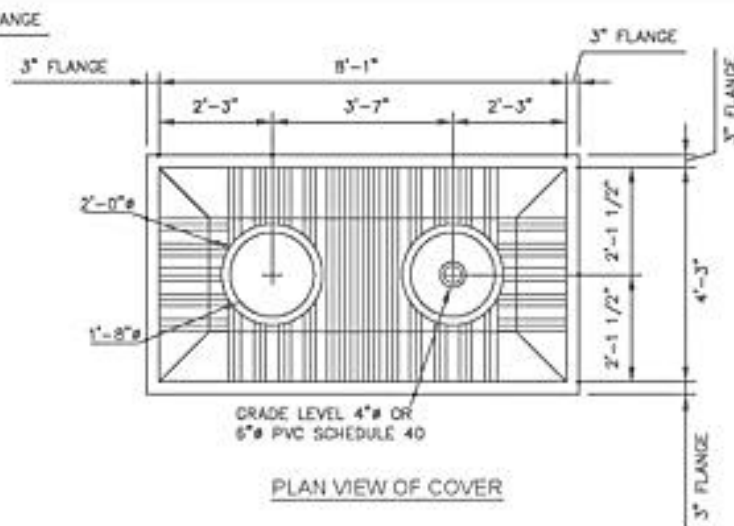

PLAN VIEW OF COVER

- NOTES:
1. ALL WALL THICKNESSES TO BE 1/4".
 2. BAFFLE RIBS TO BE AT 6" SPACING MAX.
 3. TOLERANCES: ±1/4"

MATERIAL SPECIFICATIONS

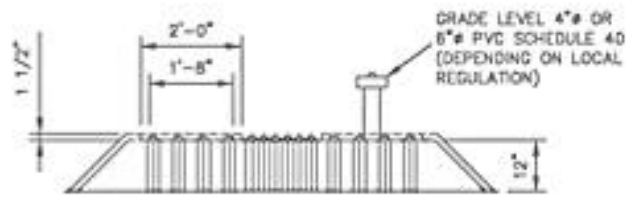

COVER ELEVATION VIEW

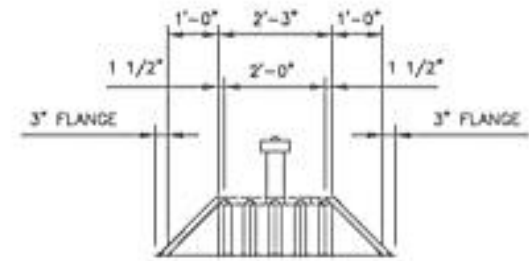

COVER ELEVATION VIEW

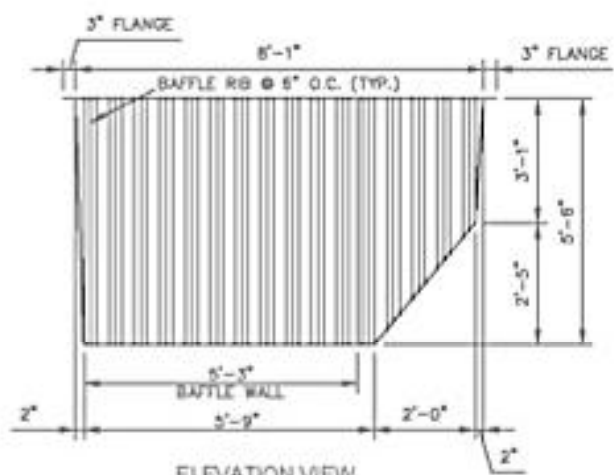

ELEVATION VIEW

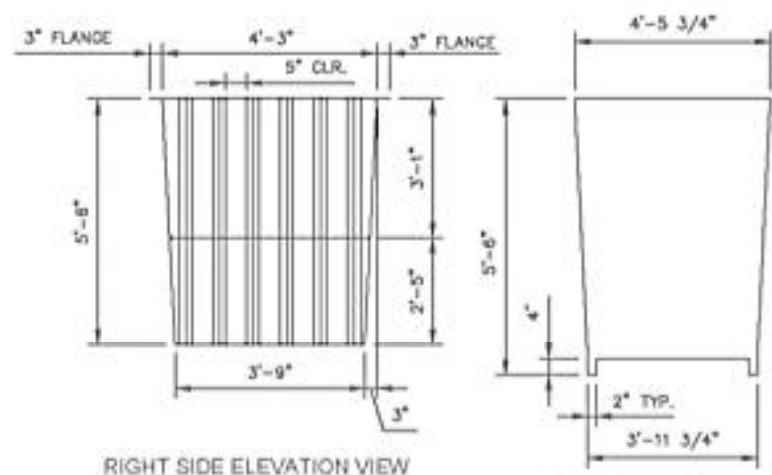

RIGHT SIDE ELEVATION VIEW

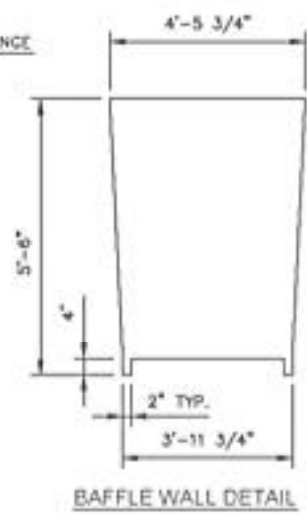

BAFFLE WALL DETAIL

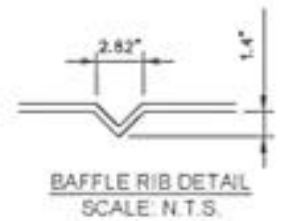

BAFFLE RIB DETAIL
SCALE: N.T.S.

AQUAKLEAR
WASTEWATER TREATMENT SYSTEM
MODEL AK800 FF
NOT TO SCALE